

PORTABLE POWER STATION 300 W

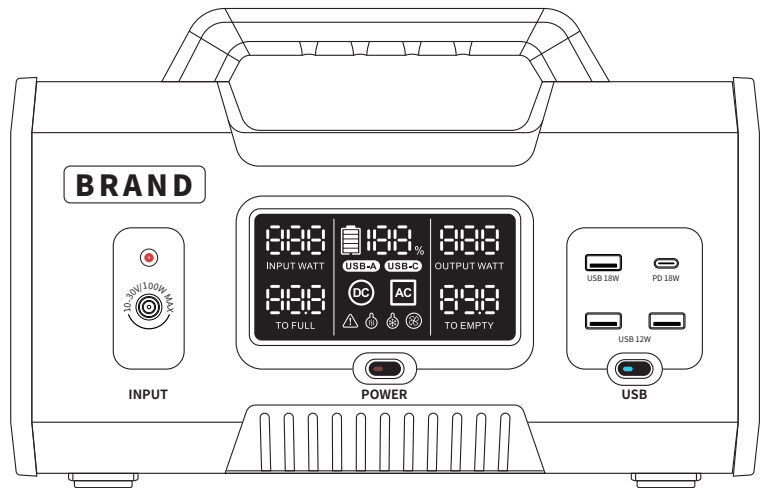

User Manual

“

DISCLAIMER

Read all safety tips, warning messages, terms of use, and disclaimers carefully. Refer to the terms of use and disclaimer on this user manual before use. Users take full responsibility for all usage and operations. Familiarize yourself with the related regulations in your area. You are solely responsible for being aware of all relevant regulations and using this product in a way that is compliant.

”

CONTENTS

1. Specifications	1
2. Safety Instructions	2
2.1 Usage	2
2.2 Safe	2
3. Getting Started	3
3.1 Product details	3
3.2 LCD Screen	4
3.3 General Product Usage	5
3.4 Usage of Audio Speaker	6
3.5 DC Charging	7
3.6 Solar Charging	7
3.7 Car Charging	8
3.8 Type-c Charging	8
4. FAQ	9
5. Troubleshooting	10
6. What's In the Box	11
7. Storage & Maintenance	11

SPECIFICATIONS

GENERAL INFO

Net Weight	≈3.7KG
Dimensions	285X138X182MM
Capacity	299.52wh (14.4V)

OUTPUT POWER

AC Output(*1)	Pure Sin Wave , 300watts total (surge 600w120V-50HZ / 60HZ)
Constant Power Max	600W (Rated Power300w)
USB-A(*3)	12W*2\18W*1
USB-C(*1)	60W Max
Car Port	12V _{DC} ,10A,120W Max

INPUT POWER

Adapter Input	100W Max
Type-c Charger	60W Max
Solar Charger	10-30V _{DC} , 100W Max
Car Charger	12V\24V,100W Max

BATTERY INFO

Cell Chemistry	NCM
Shelf Life	1 year (after a full charge)
Cycle Life	500 cycles to 80 % + capacity
Protection	Over Voltage Protection, Low TemperatureProtection , Overload Protection , ShortCircuit Protection , Overcurrent Protection, Over Charging Protect

OPERATING TEMPERATURE

Optimal Operating Temperature	20°C-30°C
Discharge Temperature	-10°C-60°C
Charge Temperature	0°C-45°C
Storage Temperature	0°C-45°C

SAFETY INSTRUCTIONS

Usage

1. Do not use the product near heat sources, such as a fire source or a heating furnace.
2. Avoid contact with any liquid. Do not immerse the product in water or get it wet. Do not use the product in rain or humid environments.
3. Do not use the product in rain or humid environments.
4. Do not use the product in an environment with strong static electricity/magnetic fields.
5. Do not disassemble the product in any way or pierce the product with sharp objects.
6. Avoid using wires or other metal objects that may result in a short circuit.
7. Do not use unofficial components or accessories.
8. When using the product, please strictly follow the operating environment temperature specified in this user manual. If the temperature is too high, it may result in a fire or explosion; if the temperature is too low, the product performance may be severely reduced, or the product may cease to work.
9. Do not stack any heavy objects on the product.
10. Do not lock the fan forcibly during use or place the product in an unventilated or dusty area.
11. Please avoid impact, falls, or severe vibrations when using the product. In case of a severe external impact, turn off the power supply immediately and stop using the product. Ensure the product is well fastened during transportation to avoid vibrations and impacts.
12. If you accidentally drop the product into water during use, please place it in a safe open area, and stay away from it until it is completely dry. The dried product should not be used again, and should be properly disposed of according to Disposal Guide below. If the product catches fire, we recommend that you use the fire extinguishers in the following order: water or water mist, sand, fire blanket, dry powder, and finally a carbon di-oxide fire extinguisher.
13. Use a dry cloth to clean off dirt on the product ports.
14. Rest the product on a flat surface to avoid damages caused by the product falling over. If the product is overturned and severely damaged, turn it off immediately, place the battery in an open area, keep it away from combustible matter and people, and dispose of it in accordance with local laws and regulations.
15. Ensure that the product is kept out of reach of children and pets.

Disposal Guide

1. If conditions permit, make sure that the battery is fully discharged before disposing it in a designated battery recycling bin. The product contains batteries with potentially dangerous chemicals, so it is strictly prohibited to dispose of it in ordinary trash cans. For more details, please follow the local laws and regulations on battery recycling and disposal.
2. If the battery cannot be fully discharged due to a product failure, please do not dispose of the battery directly in the battery recycling box. In such case, you should contact a professional battery.
3. Please dispose of over-discharged batteries that cannot be recharged.

GETTING STARTED

3.1 Product Details

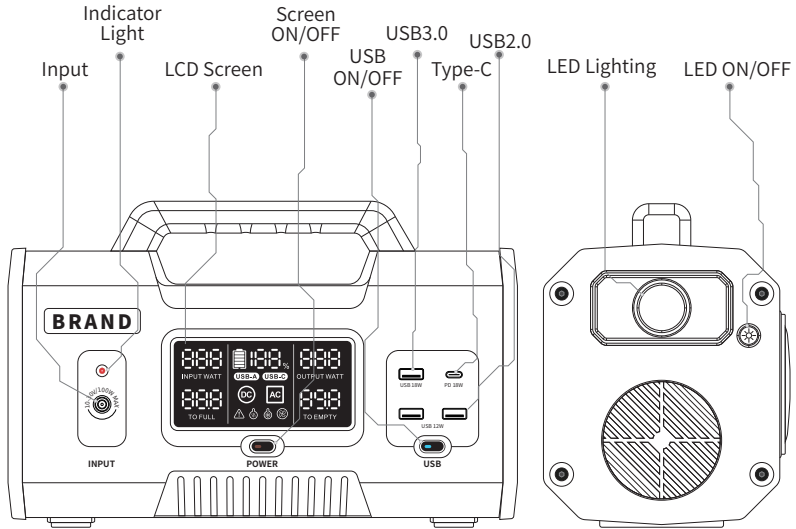

Front

Side 1

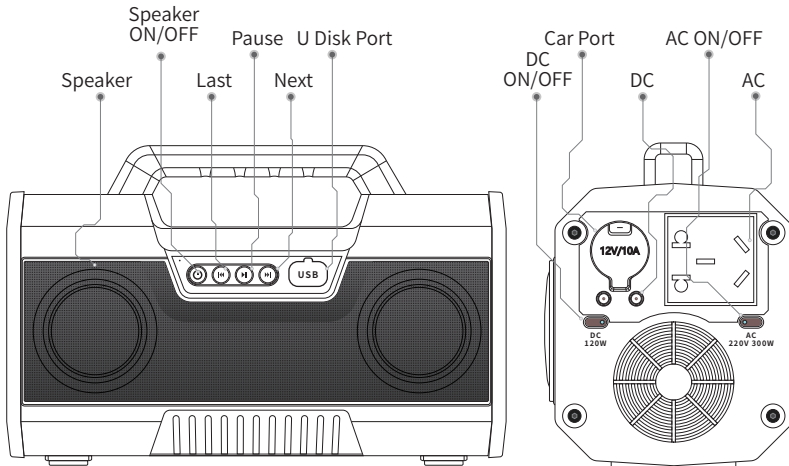

Behind

Side 2

3.2 LCD Screen

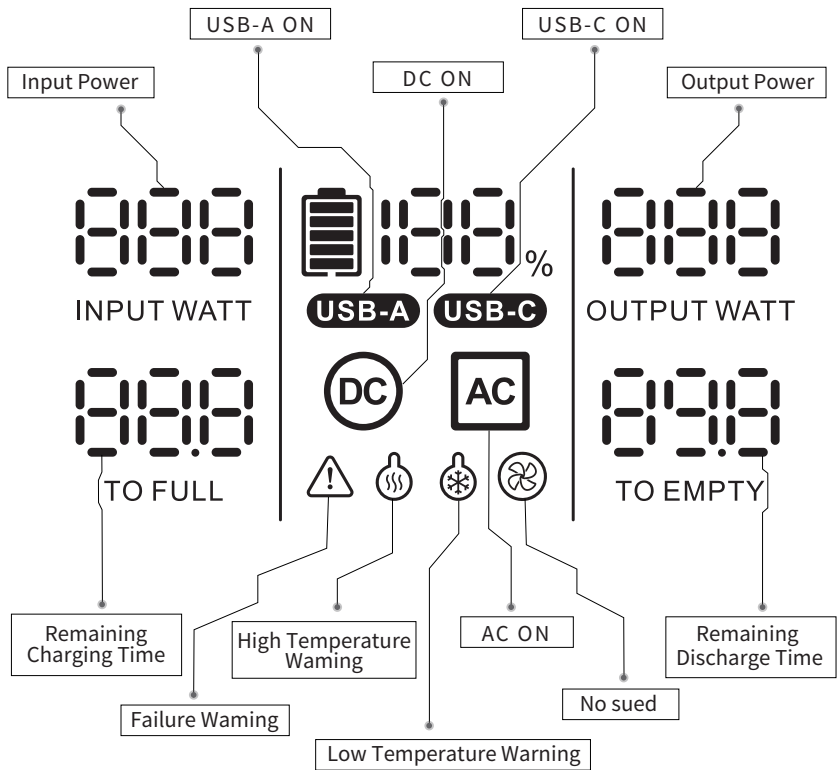

3.3 General Product Usage

Short press any buttons to turn on the product, the LCD Screen will light up.

The product will enter the power-off and sleep state when no charge or discharge for 1 minute. Short press DISPLAY button to turn on or off the LCD screen.

The LCD screen will turn off after lighting up for 30s, will keep light up when charging.

USB Output Port

Short press the USB button to turn on the USB port. Turn off the USB port by short press the - USB button again.

The product will not shut off automatically when the USB port is on.

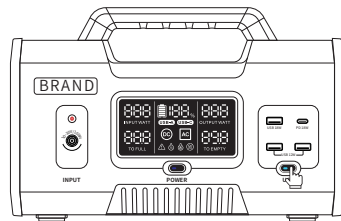

Short press the USB button

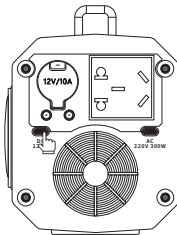

Short press the DC button

DC Output Port

Short press the DC button to turn on the DC port. Turn off the DC port by short press the DC button again.

The product will not shut off automatically when the DC port is on.

AC Output Port

Short press the AC button to turn on the AC port. Turn off the AC port by short press the AC button again.

Please turn off AC port when not in use to save power consumption.

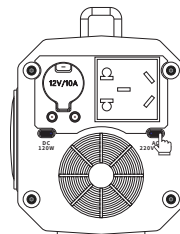

Short press the AC button

3.4 Usage of Audio Speaker

Long press the switch key to turn on the speaker, and long press the switch key again to turn off the speaker when it is turned on.

Bluetooth connection: When the speaker is turned on, use a mobile device such as a mobile phone to search for and connect to a device with a Bluetooth name of HYY-BD300w. After you hear a prompt tone of "connected", you can successfully connect to the speaker.

Note: Make sure that the device is not connected to other devices before connecting, otherwise the connection may fail.

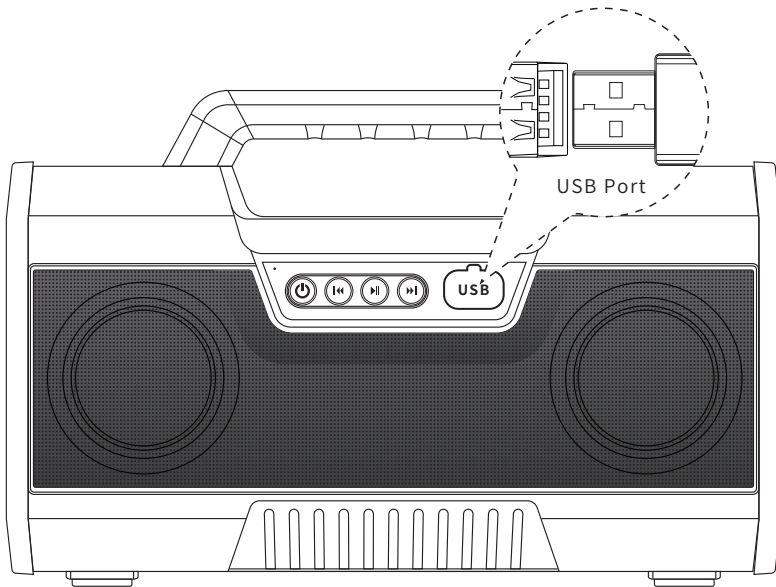

U disk connection: Insert external devices such as U disk through the USB port, the speaker will automatically detect and recognize and play music.

Playback settings:

1. Short press the Last button to switch to the previous song (long press this button to decrease the volume)
2. Short press the Next button to switch to the next song (long press this button to increase the volume)
3. Short press the PAUSE button to pause playback, short press again to resume playback.

3.5 DC Charging

The maximum charging power of this product can reach 60w, and it takes about 5hours to charge the battery from 0% to 100%.

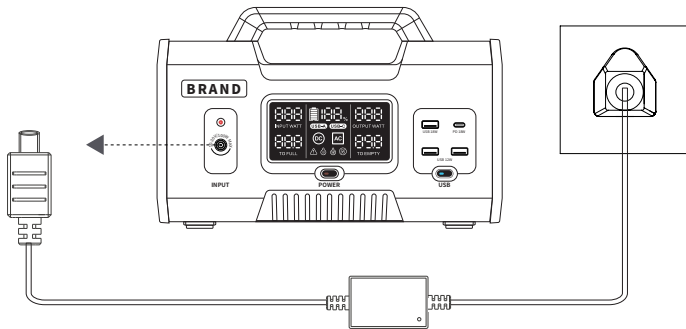

3.6 Solar Charging

Users can charging this product by solar panels, the specifications of charging port is DC 7909.

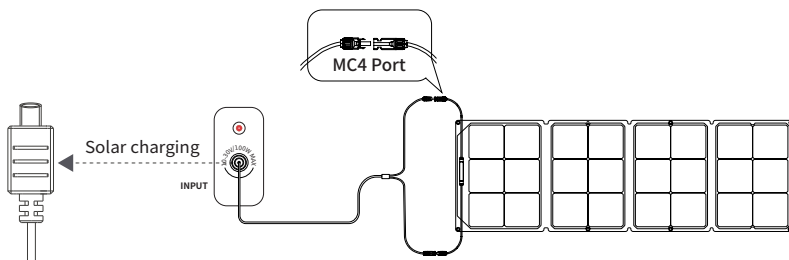

Before connecting the solar panel, please confirm whether the output voltage of the solar panel is within the product specification to avoid damage to the product damage.

3.7 Car Charging

Users can recharge the product through the car charger on the car. Please charge using the car charger after you've started the car to avoid failure to start due to insufficient car battery. In addition, please make sure that Car charging Input Port and the Car Charging Cable are in good condition.

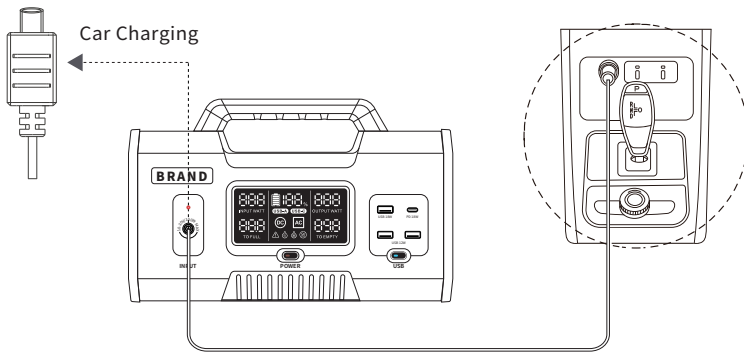

3.8 Type-C Charging

The Type-C port on this product is a bidirectional port, which can be used to charge this product. The maximum input power is 60W. Charge the device at the same time as the power adapter, and the charging time can be shortened to 2.5 hours.

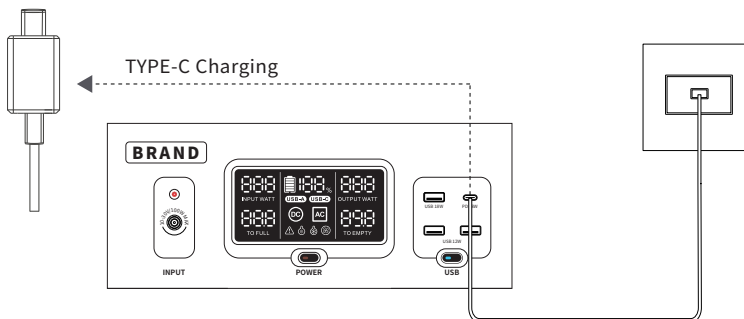

FAQS

1. What battery does the product use?

It uses high-quality NCM lithium-ion battery.

2. What devices can the product's AC output port power?

With 700w rated power and 1200w peak power, the product's AC output port can power most household appliances. Before you use it, we recommend that you confirm the power of the appliances first and ensure the power sum of all loaded appliances is lower than the rated power.

3. How long can the product charge my devices?

The remaining discharging time is shown on the product's LCD screen, which can be used to estimate the charging time of most appliances with stable power usage.

4. How can I know if the product is charging ?

When it's charging, the charging power and remaining charging time will be shown on the LCD screen.

5. How to clean the product?

Please gently wipe it with a dry, soft, clean cloth or paper towel.

6. How to store the product?









Before storing, please turn off the product first, and then store it in a dry, ventilated place at room temperature. Do not place it near water sources.

For long-term storage, please discharge the battery to 30% and recharge it to 60% every three months to extend its battery life.

7. Can I bring the product on a plane?

NO.

TROUBLESHOOTING

Problem	Indicator 1	Indicator 2	Solution
High Temperature When Charging			Temperature recovery or no charging
Low Temperature When Charging			Temperature recovery or no charging
Battery Overvoltage			Battery voltage recovery
Input Overvoltage			Input voltage recovery
High Temperature When Discharging			Temperature recovery
Low Temperature When Discharging			Temperature recovery
Overcurrent or Short Circuit When Using Quick Charging		USB	Recovery by Pressing USB Button
DC 12V Overcurrent or Short Circuit		DC	Recovery by Pressing DC Button
AC 220V Overcurrent or Short Circuit		AC	Recovery by Pressing AC Button

If an error (s) is indicated on the LCD screen during use and does not disappear after a restart, please stop using it immediately (do not try to charge or discharge).

If you require any other assistance, please contact the sales.

WHAT'S IN THE BOX

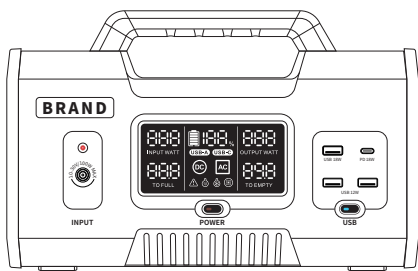

300W Portable Power Station

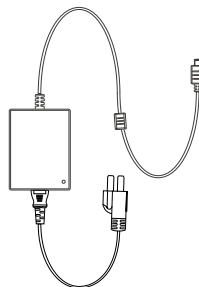

Power Adapter

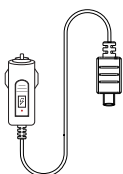

Car Charger

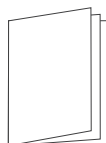

User Manual

STORAGE & MAINTENANCE

1. Please use or store the product in an environment temperature between 20 °C to 30°C, away from water, heat, and other metal objects.
2. For long-term storage, please discharge the battery to 30% and recharge it to 60% every three months.
3. For safety, please do not store the product in an environment temperature higher than 45°C or lower than 10°C for a long time.
4. If the remaining battery is less than 1% after you finish using the product, please recharge it to 60% before storing. If the battery is left idle for a long time when the battery is seriously insufficient or fully charged, it will cause irreversible damage to the battery and shorten the service life of the product.
5. If the product has been idle for too long and the battery is severely low, it will enter a deep sleep protection mode. In such case, please charge the product before using it again.

USER MANUAL

