

BICODI

USER MANUAL

RESIDENTIAL ENERGY STORAGE

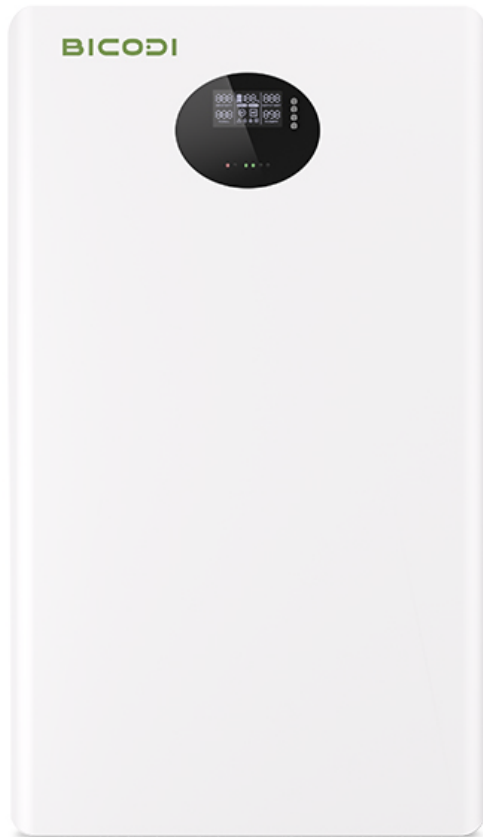

Bicodi Website

BD048200P10



ABOUT THIS MANUAL

This manual describes how to install the BD048200P10. Please read this manual carefully before you start to install the product, and follow the instructions throughout the installation process. If you are not sure about any of the requirements, recommendations, or safety procedures described in this manual, please contact Bicodi immediately for advice and clarification. The information included in this manual is accurate at the time of publication. However, with regards to the product design and technical specification updates, our company reserves the right to make changes at any time without prior notice .In addition, the illustrations in this manual are meant to help explain system configuration concepts and installation instructions. The illustrated items maybe different from the actual items at the installation location.



CONTENTS

- 1. Introduction 1
- 2. Safety Symbols 1
- 3. Safety 2
 - 3.1 Handling 2
 - 3.2 Installation 2
 - 3.3 Response to Emergency Situations 3
- 4. Product Information 4
 - 4.1 Battery Module Specifications 4
 - 4.2 Battery Charge/Discharge Curve 5
- 5. Product Features 6
 - 5.1 Battery System Specifications 6
 - 5.2 Battery Interface 6
- 6. Installation 11
 - 6.1 Items in the package 11
 - 6.2 Installation Required Tools 13
 - 6.3 Installation Environment Requirements 14
 - 6.4 Dimensions 14
 - 6.5 Installation Space Requirements 15
 - 6.6 Installation Step 15
- 7. Electrical Connection 17
 - 7.1 Electrical Connection Of One Battery Module 17
 - 7.1.1 Connecting Power Cable 17
 - 7.1.2 Connecting Communication Cable 17

7.2 Electrical Connection Of Multiple Battery Module	18
7.2.1 Connecting Power Cable	18
7.2.2 Connecting Communication Cable	18
7.2.3 Energy Storage Battery Module Address Setting	18
8. Exclusion	19
9. Maintenance and Troubleshooting	19
9.1 Maintenance	19
9.2 Troubleshooting	20

INTRODUCTION

(1)

The document describes the installation, commissioning, maintenance and troubleshooting of the following low voltage battery listed below.

BD048200P10









The battery chemistry of this product is Lithium Iron Phosphate. This manual is designed for qualified personnel only. The tasks described in this document should be performed by authorized and qualified technicians only.

SAFETY SYMBOLS

(2)

Before installing, operating and maintaining the device, please read this manual first and follow the symbols on the device and all the safety precautions in this manual.

Warning Labels

Symbols	Description
	Read the user manual carefully before using.
	This battery pack contains high voltage which can cause electric shock resulting in severe injury.
	Keep the battery pack away from open flame or ignitions sources.
	Do not allow to contact with liquid.
	Keep the battery pack away from children.
	The battery may fired
	Physical injury or damage to the devices may occur if related requirements are not followed.
	Do not dispose in trash.
	Contact the supplier within 24 hours if anything wrong.

SAFETY

(3)

Any work on the Batteries should be handled by authorized technicians and hence it is understood that the technicians should familiarize themselves with the contents of this manual before any maintenance or installation is carried out on the system.

3.1 Handling

1. Do not expose battery to open flame.
2. Do not place the product under direct sunlight.
3. Do not place the product near flammable materials. It may lead to fire or explosion in case of accident.
4. Store in a cool and dry place with ample ventilation.
5. Do not store the product near water sources.
6. Store the product on a flat surface.
7. Store the product out of reach of children and animals.
8. Do not damage the unit by dropping, deforming, impacting, cutting or penetrating with a sharp object. It may cause leakage of electrolyte or fire.
9. Do not touch any liquid spilled from the product. There is a risk of electric shock or damage to skin.
10. Always handle the battery wearing the insulated gloves.
11. Do not step on the product or place any foreign objects on it. This can result in damage.
12. Do not charge or discharge damaged battery.
13. Do not store the battery near water sources.

3.2 Installation

1. Do not connect the BD048100P05 to inverter conductors or Photo-Voltaic conductors. This will damage the battery and may result in explosion.
2. After unpacking, please check the product for damages and missing parts.
3. Make sure that the inverter and battery is completely turned off before commencing installation.
4. Do not interchange the positive and negative terminals of the battery.
5. Ensure that there is no short circuit of the terminals or with any external device.
6. Do not exceed the battery voltage rating of the inverter.
7. Do not connect the battery to any incompatible inverter.
8. Do not connect different battery types together.
9. Please ensure that all the batteries are grounded properly.
10. Do not open the battery to repair or disassemble. Only manufacturer is allowed to carry out any such repairs.
11. In case of fire, use only dry powder fire extinguisher. Liquid extinguishers should not be used.
12. Install the batteries only inside approved manufacturer enclosure. Installing the battery anywhere outside is strictly forbidden.

13. Do not install the battery near water sources or places where the battery can get wet.
14. Install the battery away from children or pets.
15. Do not use battery in high static environment where the protection device might be damaged.
16. Do not install with other batteries or cells.
17. Batteries with different color labels cannot be connected in parallel.

3.3 Response to Emergency Situations

The battery can be used in single or multi in parallel. It is designed to prevent hazards or failures. However, manufacturer cannot guarantee their absolute safety.

Under exposure to the internal materials of the battery the following recommendations should be carried out by the user.

1. If there has been inhalation, please leave the contaminated area immediately and seek medical attention.
2. If there has been contact with eyes, rinse the eyes with running water for 15 minutes and seek medical attention immediately
3. If there has been contact with the skin, wash the contacted area with soap thoroughly and seek
4. medical attention immediately.
If there has been ingestion, induce vomiting and seek medical attention.

Fire Situation

In situations where the battery is on fire, if it is safe to do so, disconnect the battery pack by turning of the switch to shut off the power to the system. Use FM—200 or Co2 fire extinguisher for the battery and an ABC fire extinguisher for the other parts of the system.

Under any fire situation, please evacuate the people from the building immediately before trying to extinguish it.

Water Situation

The battery modules are not water resistant. Hence care should be taken not to get it wet. If you find the battery completely or partially submerged in water do not try to open. Contact authorized personnel or manufacturer for further instructions.

PRODUCT INFORMATION

(4)

BD048200P10 photovoltaic energy storage system is a 51.2V energy storage system based on lithium-ion ferrous phosphate battery. It is equipped with a customized battery management system (BMS), which is designed for energy storage applications of household photovoltaic power generation users. In the daytime, the surplus power of photovoltaic power generation can be stored in the battery. At night or when necessary, the stored energy can be provided to the electrical equipment, it can improve the use efficiency of photovoltaic power generation, peak-load shifting, and provide emergency standby power.

4.1 Battery Module Specifications

Specification for Battery		Note
Battery module	BD048200P10	
Nominal capacity (Ah)	200	0.5C, 25℃
Nominal voltage (Vdc)	51.2	
Nominal energy (kWh)	10.24	
Battery voltage range (Vdc)	42-58.4	
Recommend charging current(A)	100	
Recommend discharging current(A)	100	
Max. continuous discharging current (A)	200	
Max. continuous charging current (A)	200	
Cycle life	≥ 6000@25℃	
Storage temperature	-20-45℃	
Operating temperature range	Charge:0℃-55℃	
Discharge	Discharge:-20℃-60℃	
Energy density (Wh/kg)	169	
Ingress protection	IP20	
Communication	RS485/CAN	
Weight(kg)	93.5	
Dimensions (L*W*H) (mm)	860*500*138	

4.2 Battery Charge/Discharge Curve

Current protection			
		Trigger	Recover
Charge	First level over current	$\geq 225A$, Lasts 10S	10min
	Second level over current	$\geq 240A$, Lasts 500mS	10min
Discharge	First level over current	$\geq 225A$, Lasts 10S	1min
	Second level over current	$\geq 240A$, Lasts 500mS	1min

PRODUCT FEATURES

(5)

5.1 Battery System Specifications

The batteries have been fitted with multiple protection systems to ensure the safe operation of the system. Some of the protection system includes:

- Battery Protection: External short circuit, over voltage, over current, over temp, under voltage, under temp.

The battery system contains the following Interface to allow it to connect and operate efficiently.

5.2 Battery Interface:

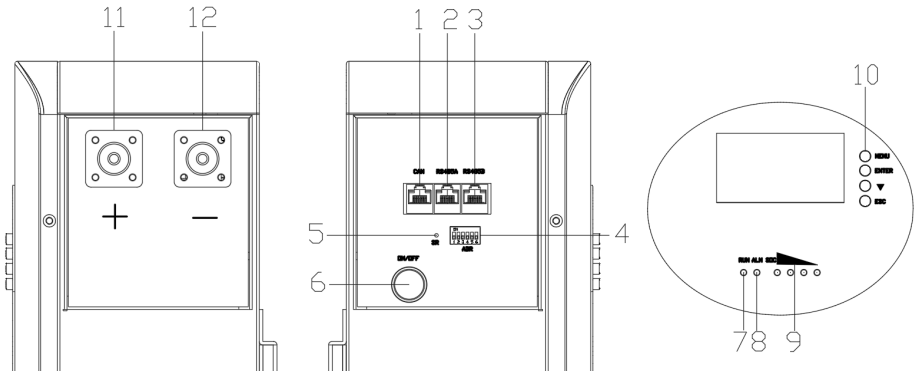

Location	Port	Location	Port
1	CAN/RS485	7	Running LED
2	RS485A	8	Alarm LED
3	RS485B	9	SOC LED
4	ADD switch	10	LCD button
5	Reset switch	11	Positive terminal
6	Power switch	12	Negative terminal

RS485A/RS485B

For communication between multiple parallel batteries.
Definition of RJ45 Port Pin.

Pin \ Port	RS485A	RS485B
Pin 1	485B	485B
Pin 2	485A	485A
Pin 3	GND	GND
Pin 4	NC	NC
Pin 5	NC	NC
Pin 6	GND	GND
Pin 7	485A	485A
Pin 8	485B	485B

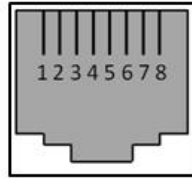

RJ45 Port



RJ45 Plug

CAN /RS485

CAN/RS485 is the communication interface to the inverter.
Definition of RJ45 Port Pin.

Pin \ Port	RS485	CAN
Pin 1	485B	
Pin 2	485A	
Pin 3	GND	
Pin 4		CANH
Pin 5		CANL
Pin 6	GND	
Pin 7	485A	
Pin 8	485B	

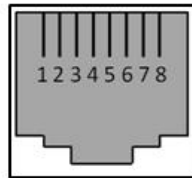

RJ45 Port



RJ45 Plug

Reset switch

Press more than 6s to reset the battery.

ADD switch

Dip1~4:Address of multiple battery group connection.

Dip5~6:BMS communication protocol for different inverter setting.

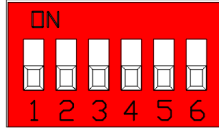

Dip1	Dip2	Dip3	Dip4	Group address number
OFF	OFF	OFF	OFF	0: 0 master battery
ON	OFF	OFF	OFF	1: 1 st slave battery
OFF	ON	OFF	OFF	2: 2 nd slave battery
ON	ON	OFF	OFF	3: 3 rd slave battery
OFF	OFF	ON	OFF	4: 4 th slave battery
ON	OFF	ON	OFF	5: 5 th slave battery
OFF	ON	ON	OFF	6: 6 th slave battery
ON	ON	ON	OFF	7: 7 th slave battery
OFF	OFF	OFF	ON	8: 8 th slave battery
ON	OFF	OFF	ON	9: 9 th slave battery
OFF	ON	OFF	ON	10: 10 th slave battery
ON	ON	OFF	ON	11: 11 th slave battery
OFF	OFF	ON	ON	12: 12 th slave battery
ON	OFF	ON	ON	13: 13 th slave battery
OFF	ON	ON	ON	14: 14 th slave battery
ON	ON	ON	ON	15: 15 th slave battery

When communicate with the inverter through the RS485 interface, you need to change the ADD Dip5 and Dip6 setting of master battery to chose BMS communication protocol for different inverter.

Dip5	Dip6	Master Battery Setting	BMS communication protocol
OFF	OFF	Master Battery Setting 1	SRNE
OFF	ON	Master Battery Setting 2	Voltronic
ON	OFF	Master Battery Setting 3	Reserved
ON	ON	Master Battery Setting 4	Growatt

When communicate with the inverter through the CAN interface, you need to change the ADD Dip5 and Dip6 setting of master battery to chose BMS communication protocol for different inverter.

Dip5	Dip6	Master Battery Setting	BMS communication protocol
OFF	OFF	Master Battery Setting 1	Luxpowertek
OFF	ON	Master Battery Setting 2	Pylontech, Deye, Goodwe, Solis, TBB, Sorotec, Megarevo, Senergy
ON	OFF	Master Battery Setting 3	Victron, SMA, Sofar
ON	ON	Master Battery Setting 4	Growatt

LED Status Indicators

There are six LED indicators of the battery packs to show its operating status .

SOC4	SOC3	SOC2	SOC1		
				ALARM	RUN

LED ON	LED OFF	LED Flash 1 ON 0.25S OFF 3.75S	LED Flash 2 ON 0.5S OFF 0.5S	LED Flash 3 ON 0.5S OFF 1.5S

Condition	Status	SOC	SOC4	SOC3	SOC2	SOC1	ALA	RUN
Shutdown	Shutdown	/						
Standby	Normal	0~25%						
		25~50%						
		50~75%						
		75~100%						
	Alarm*1	0~25%						
		25~50%						
		50~75%						
		75~100%						

Condition	Status	SOC	SOC4	SOC3	SOC2	SOC1	ALA	RUN
Charging	Normal	0~25%						
		25~50%						
		50~75%						
		75~100%						
	Alarm* ²	0~25%						
		25~50%						
		50~75%						
		75~100%						
	High Voltage Protect, Over Current Protect	0~25%						
		25~50%						
		50~75%						
		75~100%						
	Temperature Protect	/						
Discharging	Normal	0~25%						
		25~50%						
		50~75%						
		75~100%						
	Alarm* ³	0~25%						
		25~50%						
		50~75%						
		75~100%						
	Low Voltage Protect	0~25%						
		25~50%						
		50~75%						
		75~100%						
	Over Current Protect, Short Circuit Protect, Temperature Protect	/						
Fault	NTC Fault, MOS Fault, LOW Voltage Fault	0~100%						

Power switch

ON: ready to turn on.

OFF: power off. For storage or shipping.

Power Terminals

A set of positive and negative terminals to connect the battery to the inverter. When you are unplugging the wires from the terminals, make sure you press the lock button and then pull it. When installing the plug, do not press the button and push the plug until you hear a click sound.







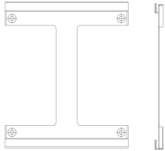

INSTALLATION

(6)

6.1 Items in the package

Please check if following items are including with the package.

NO	Picture	Item	Quantity	Specification
1		Battery Pack	1	51.2V, 10.24kWh
2		Mounting Frame	1	423*356mm
3		Expansion bolt	4	M8*70 expansion bolt
4		Power Plug	2	HV10-M8035-C1/ C2-X/200A/1500V

5		Communication Cable	1	Double RJ45 plug/2m
6		Warranty Card	1	120*90mm
7		Passport Card	1	120*90mm
8		User Manual	1	140*210mm

Communication Cable

CONN.1 and CONN.2 PIN definition:

Pin	Definition
1	White-orange
2	Orange
3	White-green
4	Blue
5	White-blue
6	Green
7	White-brown
8	Brown



The communication cable is a standard network cable. If the definition of the communication port from your inverter to the battery is different, please make your own communication cable.

Power cable terminal making instructions

- (A) Core wire
- (B) Insulation layer
- (C) Heat shrink tubing
- (D) Hydraulic pliers
- (E) Heat gun

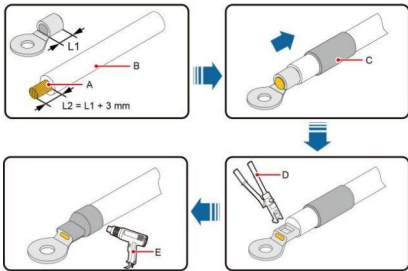



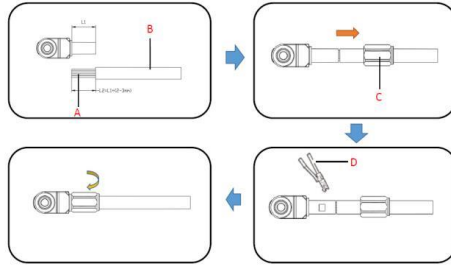





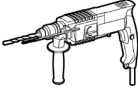

- (A) Core wire
- (B) Insulation layer
- (C) Protective cover
- (D) Hydraulic pliers

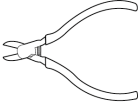

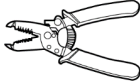

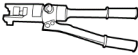

6.2 Installation Required Tools

The following tools are required to install the PACK:

			
Hammer drill	Torque wrench	Steel measuring	Level
			
Diagonal pliers	Rubber mallet	Marker	Wire strippers
			
Heat gun	Hydraulic pliers	Heat-shrink tubing	Multimeter

It is recommend to wear the following safety gear when dealing with the PACK .

			
Safety Goggles	Insulated Glove	Safety Shoes	Dust mask

6.3 Installation Environment Requirements

- 1. Install the battery in the indoor environment .
- 2. Place battery in secure location away from children and animals.
- 3. Do not place the battery near any heat source and avoid sparks .
- 4. Do not expose the battery to moisture or liquids.
- 5. Do not expose the battery to direct sunlight.

6.4 Dimensions

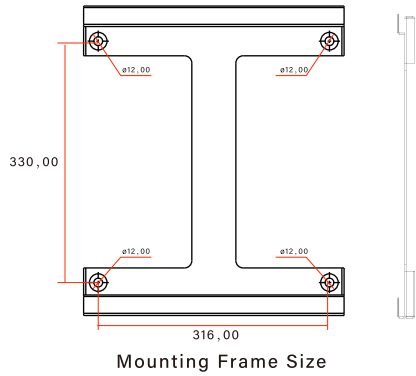
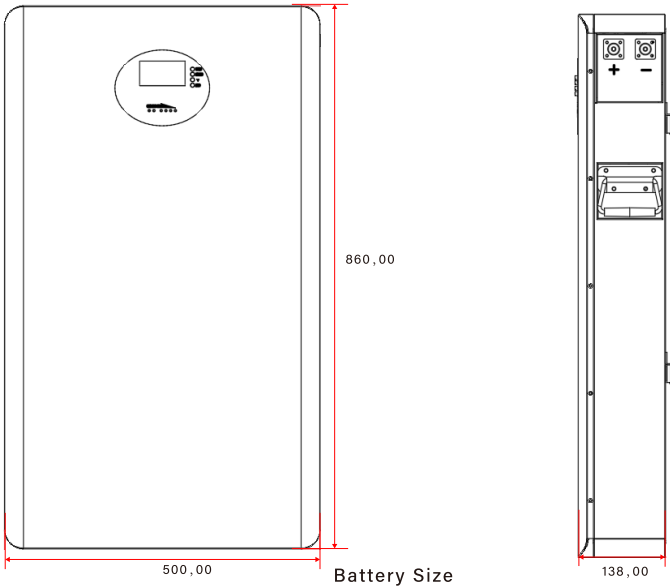

6.5 Installation Space Requirements

The battery should be placed in the right position first, and the installation site should be smooth and the wall should be solid, and the device is 50cm away from the ground, the distance between the batteries should be greater than 30-50cm.

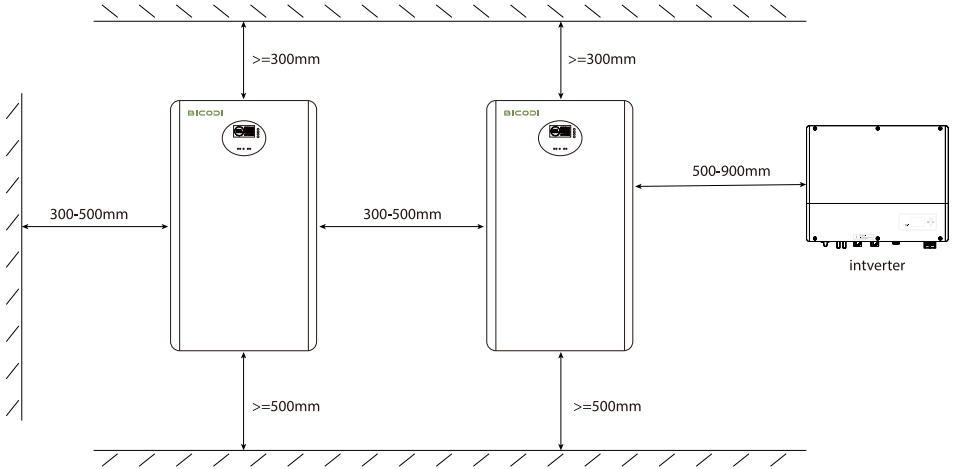

6.6 Installation Step

Step 1

Determine the installation position, put the mounting frame in the proper position of the wall, and mark the place where the holes need to be punched.

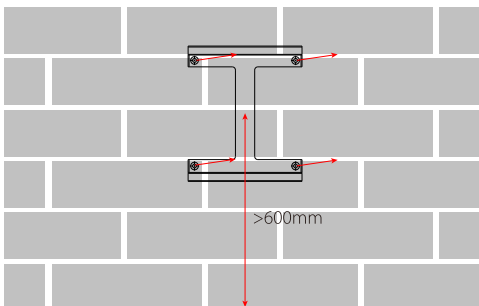

Step 2

Drill holes with hammer drill, make sure the holes are deep enough(at least 70mm) for installation, and then tighten the expansion bolt.

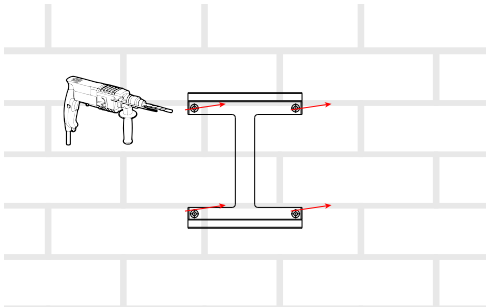

Step 3

Install the mounting frame to the 4 screws.

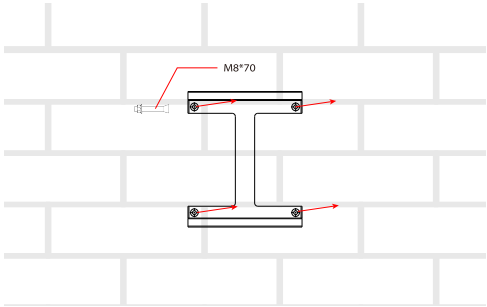

Step 4

Putting the battery hook on the mounting frame.

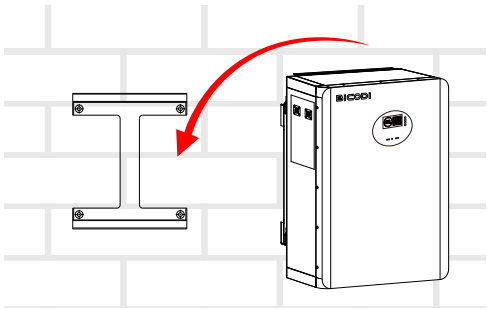

ELECTRICAL CONNECTION

(7)

7.1 Electrical Connection Of One Battery Module

7.1.1 Connecting Power Cable

When connecting the battery wiring , please make sure that the battery power switch is off and the indicator light is off .

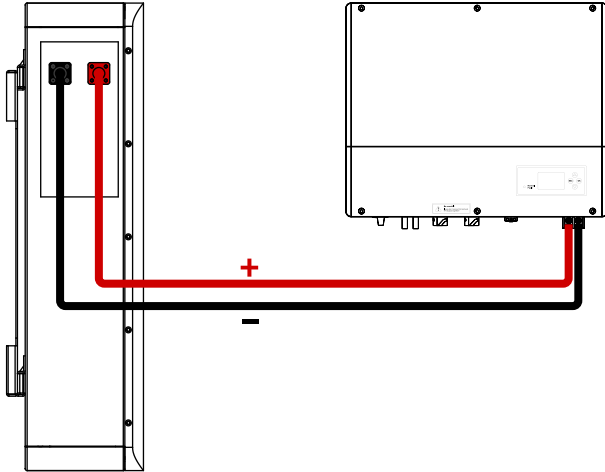

7.1.2 Connecting Communication Cable

Select an interface (CAN/RS485) based on the actual inverter interface type. The communication cable is a standard network cable. If the definition of the communication port from your inverter to the battery is different, please make your own communication cable.

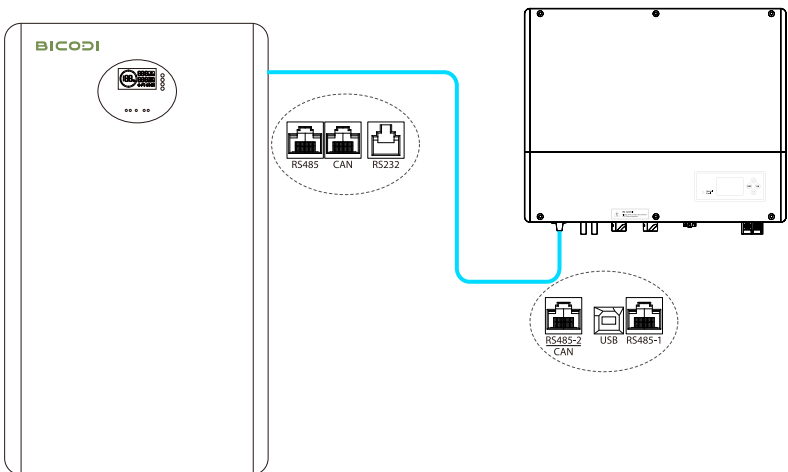

7.2 Electrical Connection Of Multiple Battery Module

7.2.1 Connecting Power Cable

When the battery is used in parallel, it supports up to 16 battery module in parallel. Each battery use power cable connect to the power distribution box ,the over-current capacity of the distribution box should be much higher than the maximum nominal current value when the load is running.

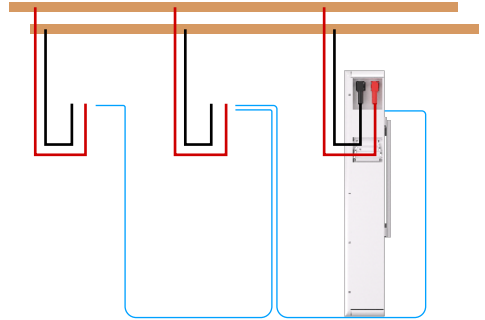

7.2.2 Connecting Communication Cable

If there are multiple batteries, you need to connect the communication cable of each battery. Battery and battery connection use RS485-485 interface , battery and inverter connection need RS485/CAN interface.

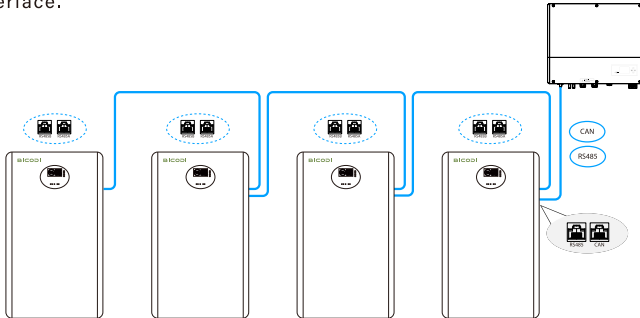

7.2.3 Energy Storage Battery Module Address Setting

If multiple energy storage battery modules are used in parallel, the address of the energy storage battery module needs to be set. The address should be set as follow picture, and the address of each module cannot be repeated.

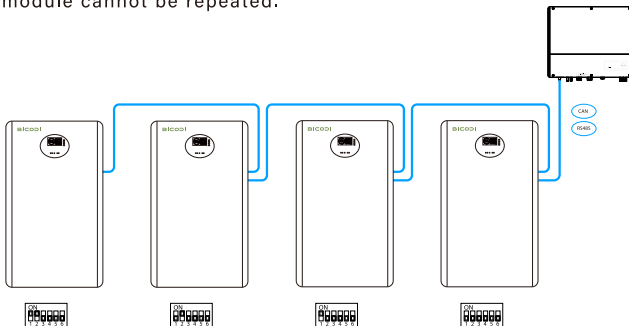

EXCLUSION

(8)

The warranty shall not cover the defects caused by normal wear and tear, inadequate maintenance, handling, storage faulty repair, modifications to the battery or pack by a third party other than manufacturer or manufacturer agent, failure to observe the product specification provided herein or improper use or installation, including but not limited to the following.

1. Damage during transport or storage.
2. Incorrect Installation of battery into pack or maintenance.
3. Use of battery pr pack in inappropriate environment.
4. Improper, inadequate, or incorrect charge, discharge or production circuit other than stipulated herein.
5. Incorrect use or inappropriate use.
6. Insufficient ventilation.
7. Ignoring applicable safety warnings and instructions.
8. Altering or attempted repairs y unauthorized personnel.
9. In case of force majeure (ex: lightning, storm, flood, fire, earthquake, etc.).
10. There are no warranties-IMPLIED or express—other than those stipulated herein. manufacturer shall not be liable for any consequential or indirect damages arising or in connection with the product specification, battery or pack.

MAINTENANCE AND TROUBLESHOOTING

(9)

9.1 Maintenance

- 1) It is recommended that the battery storage time is not more than 6 months.
- 2) It is required to charge the battery at least once every 6 months, for this charge maintenance make sure the SOC is charged to higher than 70%. In the condition of 90% charging. It is recommended that the customers use low-voltage inverter and fill the battery every half month, otherwise the SOC will be deviated.
- 3) Every year after installation. The connection of power connector, grounding point, power cable and screw are suggested to be checked. Make sure there is no loose, no broken, no corrosion at connection point. Check the installation environment such as dust, water, insect etc. Make sure it is suitable for IP21 battery system.

9.2 Troubleshooting

When the red / green LED on the panel is flashing or normally on, it does not mean that the battery is abnormal, it may be just an alarm or protection. Please check the 'LED status indicators' in chapter 5 for the detailed faulty definition before any trouble-shooting steps. In general, the alarm indication is normal without manual intervention. When the alarm triggering state is removed, battery will automatically return to normal use.

- Problem determination based on the following points

- 1) Whether the green light on the power switch is on;
- 2) Whether the buzzer in BMS is on;
- 3) Whether the battery system can be communicated with inverter;
- 4) Whether the battery can be output voltage or not.

- Preliminary determination steps

- 1) Battery system cannot work, when Power Switch on, the LED doesn't light up or flash, please consider contact the local distributor.
- 2) The LED display of BMS is normal, but it cannot charge and discharge. Observe the display screen of inverter and there is no SOC. Please check whether the RS485/CAN communication between BMS to inverter is well connected. If the connection is good, please replace a RS485/-CAN communication cable. If the SOC is still not visible on the inverter display screen, please contact the local distributor.
- 3) After the battery system is powered on, if you can see the alarm information on the LED and inverter display screen at the same time, please contact the local distributor.

BICODI

www.bicodi.com
Shenzhen Bicodi New Energy Co.,Ltd